

# MINIATURE Switch

# E21-E36 Series

Not recommended for new designs

Please review our D4 series

<http://www.cherrycorp.com/english/switches/miniature/d4.htm>

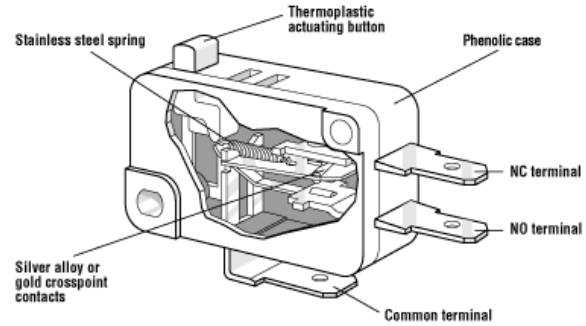
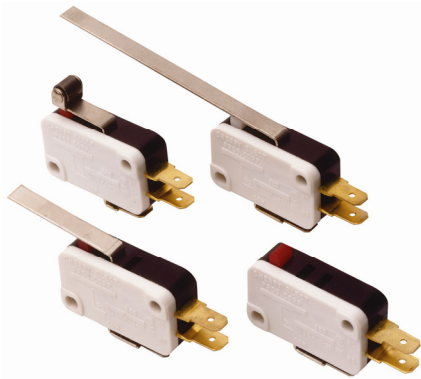

## Features

<ul style="list-style-type: none"> <li>• 8 Contact Ratings DC ratings optional</li> <li>• High temperature versions optional</li> </ul>	<ul style="list-style-type: none"> <li>• Standard or light force versions available</li> <li>• Agency approved long life versions optional</li> </ul>
---	---

## Electrical Ratings and Operating Life

Switch Series	According to UL 1054	
	Nominal Load	Electrical Life at Rated Load
E21	0.1A 125 VAC (0.25A, 30VDC optional)	6000**
E22	3A 125/250 VAC, 1/10 HP 250 VAC (0.1A, 125VDC optional)	6000
E23	5A ¼ HP, 125/250 VAC	6000
E31	1A 125 VAC	6000
E33	10A ½ HP 125/250 VAC (6A 30VDC optional)	6000**
E34	15A ½ HP 125/250 VAC	6000*
E35	20.1A ½ HP 125/250 VAC	6000
E36	25A 125/250 VAC; 1 HP 125 VAC, 2 HP 250 VAC	6000

\* Indicates 100K UL Life available on AC versions optional. \*\* Indicates 100K UL Life available on AC and DC versions optional Contact Factory for new part number.

## Technical Specifications

**Temperature Rating:** -40°C to 85°C (130°C and 150°C optional. Not available on E36. Contact factory for special part numbers.)

**Flammability Rating:** UL94HB

**Mounting:** Recommended screw: #4-40 round head, UL approved. Recommended torque: 3 inch lbs. max

**UL File No.:** E23301

**RoHS:** Compliant

Specifications subject to change

## Material Specifications

**Case:** General Purpose Phenolic

**Common Terminal:** Silver Plated Brass (E21, E22, E23, E31, E33, E34, E35) Silver Plated Copper (E36)

**NO & NC Terminal:** Brass (E21, E22, E23, E31, E33, E34, E35) Copper (E36)

**Moving Blade:** Brass (E21, E33, E23) Silver Plated Beryllium Copper (E31, E33, E34, E35, E36)

**Actuating Button:** Thermoplastic Acetal

**Auxiliary Actuator:** Cold Rolled Steel (Nickel Plated) (E21 and E22 use Aluminum)

**Contacts:** Silver Alloy  
Gold Crosspoint: E21 and E31  
Fine Silver: E22



E34 only



UL approval only on E35



MINIATURE

# E21-E36 Series

Dimensions inches

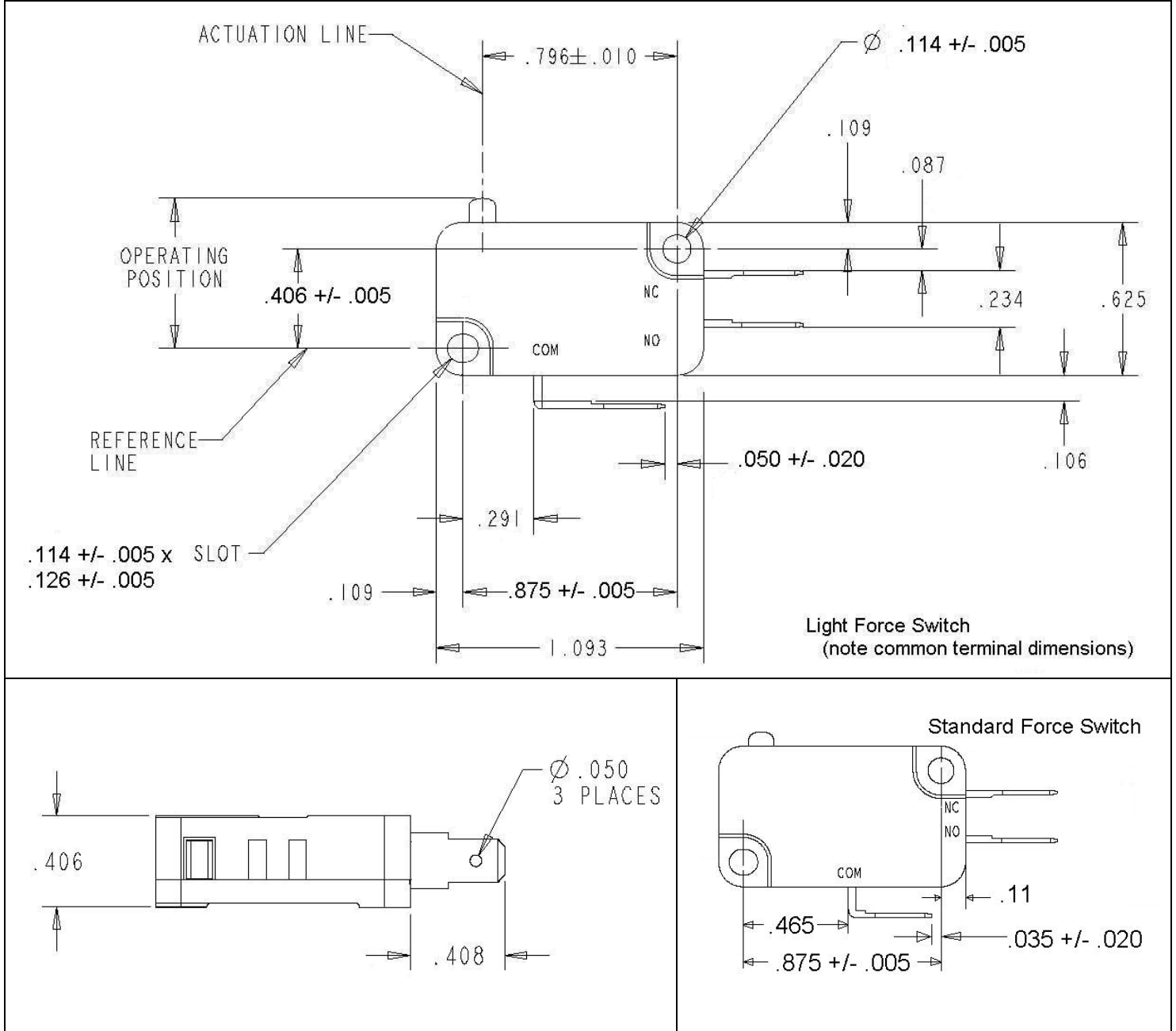

MINIATURE

# E21-E36 Series

## Actuators

Standard type integral hinged lever and roller actuators are available in choice of 2 mounting positions. Actuation lengths are dimensioned from the centerline of the switch mounting hole as shown.

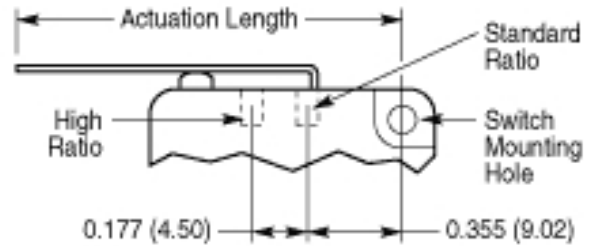

Plastic Actuator for -90N and -90NX switches	Plastic Actuator for -50N and -50NX switches
<p>Diagram illustrating the dimensions and labels for the plastic actuator for -90N and -90NX switches. The actuation length is 1.332 +/- .031. The operating position is .735 to .851. The actuation line is shown with a radius of R .09.</p>	<p>Diagram illustrating the dimensions and labels for the plastic actuator for -50N and -50NX switches. The actuation length is 1.382. The operating position is .555 to .645. The reference line is shown. The common terminal is labeled COM, and the normally open and normally closed terminals are labeled NO and NC.</p>
Roller Actuator	Straight Leaf Actuator
<p>Diagram illustrating the dimensions and labels for the roller actuator. The reference dimensions are 0.182" and 0.187" (Ref).</p>	<p>Diagram illustrating the dimensions and labels for the straight leaf actuator. The dimensions are .180 and .025.</p>

Note: Plastic levers only available on 85°C rated switches

MINIATURE

# E21-E36 Series

Not recommended for new designs

Please review our D4 series

<http://www.cherrycorp.com/english/switches/miniature/d4.htm>

## Actuator Specifications

Item Number	Actuator	UL Rating	Maximum Operating Force (grams)	Maximum Protravel inches (mm)	Operating Point* inches (mm)	Minimum Overtravel inches (mm)	Max. Movement Differential inches (mm)	Actuation Length**
0E2100AX		0.1A, 125VAC (0.25A, 30VDC optional)	15	0.047 (1.19)	0.578 +/- 0.020 (14.68 +/- 0.51)	.050 (1.27)	0.010 (0.25)	N/A
0E2100K0		0.1A, 125VAC (0.25A, 30VDC optional)	75	0.047 (1.19)	0.806 +/- 0.030 (20.47 +/- 0.76)	0.040 (1.02)	0.010 (0.25)	0.810 (20.57)
0E2150H0		0.1A, 125VAC (0.25A, 30VDC optional)	35	0.125 (3.18)	0.600 +/- 0.045 (15.24 +/- 0.51)	0.085 (2.16)	0.030 (0.76)	1.40 (35.56)
0E2200AX		3A, 125/250VAC 1/10HP, 250VAC (0.1A, 125VDC optional)	15	0.047 (1.19)	0.578 +/- 0.020 (14.68 +/- 0.51)	.050 (1.27)	0.010 (0.25)	N/A
0E2200K0		3A, 125/250VAC 1/10HP, 250VAC (0.1A, 125VDC optional)	75	0.047 (1.19)	0.806 +/- 0.030 (20.47 +/- 0.76)	0.040 (1.02)	0.010 (0.25)	0.810 (20.57)
0E2250HX		3A, 125/250VAC 1/10HP, 250VAC (0.1A, 125VDC optional)	8	0.125 (3.18)	0.600 +/- 0.045 (15.24 +/- 0.51)	0.085 (2.16)	0.030 (0.76)	1.40 (35.56)
0E2250K0		3A, 125/250VAC 1/10HP, 250VAC (0.1A, 125VDC optional)	35	0.125 (3.18)	0.806 +/- 0.045 (20.47 +/- 1.14)	0.085 (2.16)	0.030 (0.76)	1.34 (34.04)
0E2250KL		3A, 125/250VAC 1/10HP, 250VAC (0.1A, 125VDC optional)	25	0.200 (5.08)	0.806 +/- 0.075 (20.47 +/- 1.91)	0.120 (3.05)	0.040 (1.02)	1.516 (38.51)
0E2255HX		3A, 125/250VAC 1/10HP, 250VAC (0.1A, 125VDC optional)	4	0.300 (7.62)	0.600 +/- 0.100 (15.24 +/- 2.54)	0.187 (4.75)	0.065 (1.65)	2.757 (70.03)
0E2285HX		3A, 125/250VAC 1/10HP, 250VAC (0.1A, 125VDC optional)	2	0.500 (12.70)	0.600 +/- 0.175 (15.24 +/- 4.45)	0.312 (7.92)	0.100 (2.54)	2.932 (74.47)
0E2300A0		5A, 1/4HP, 125/250VAC	170	0.047 (1.19)	0.578 +/- 0.020 (14.68 +/- 0.51)	.050 (1.27)	0.010 (0.25)	N/A
0E2300K0		5A, 1/4HP, 125/250VAC	170	0.047 (1.19)	0.806 +/- 0.030 (20.47 +/- 0.76)	0.040 (1.02)	0.010 (0.25)	0.810 (20.57)
0E2350H0		5A, 1/4HP, 125/250VAC	85	0.125 (3.18)	0.600 +/- 0.045 (15.24 +/- 0.51)	0.085 (2.16)	0.030 (0.76)	1.40 (35.56)
0E2350K0		5A, 1/4HP, 125/250VAC	86	0.125 (3.18)	0.806 +/- 0.045 (20.47 +/- 1.14)	0.085 (2.16)	0.030 (0.76)	1.34 (34.04)
0E2355HX		5A, 1/4HP, 125/250VAC	10	0.300 (7.62)	0.600 +/- 0.100 (15.24 +/- 2.54)	0.187 (4.75)	0.065 (1.65)	2.757 (70.03)
0E2385HX		5A, 1/4HP, 125/250VAC	6	0.500 (12.70)	0.600 +/- 0.175 (15.24 +/- 4.45)	0.312 (7.92)	0.100 (2.54)	2.932 (74.47)
0E3300A0		10A, 1/2HP, 125/250VAC (6A, 30VDC optional)	285	0.047 (1.19)	0.578 +/- 0.020 (14.68 +/- 0.51)	.050 (1.27)	0.010 (0.25)	N/A
0E3300AX		10A, 1/2HP, 125/250VAC (6A, 30VDC optional)	75	0.047 (1.19)	0.578 +/- 0.020 (14.68 +/- 0.51)	.050 (1.27)	0.010 (0.25)	N/A
0E3300K0		10A, 1/2HP, 125/250VAC (6A, 30VDC optional)	285	0.047 (1.19)	0.806 +/- 0.030 (20.47 +/- 0.76)	0.040 (1.02)	0.010 (0.25)	0.810 (20.57)
0E3350H0		10A, 1/2HP, 125/250VAC (6A, 30VDC optional)	144	0.125 (3.18)	0.600 +/- 0.045 (15.24 +/- 0.51)	0.085 (2.16)	0.030 (0.76)	1.40 (35.56)
0E3350HL		10A, 1/2HP, 125/250VAC (6A, 30VDC optional)	86	0.220 (5.59)	0.600 +/- 0.075 (15.24 +/- 1.91)	0.130 (3.30)	0.040 (1.02)	1.580 (40.13)
0E3350K0		10A, 1/2HP, 125/250VAC (6A, 30VDC optional)	144	0.125 (3.18)	0.806 +/- 0.045 (20.47 +/- 1.14)	0.085 (2.16)	0.030 (0.76)	1.34 (34.04)
0E3385HX		10A, 1/2HP, 125/250VAC (6A, 30VDC optional)	10	0.500 (12.70)	0.600 +/- 0.175 (15.24 +/- 4.45)	0.312 (7.92)	0.100 (2.54)	2.932 (74.47)
0E3400A0		15A, 1/2HP, 125/250VAC	400	0.047 (1.19)	0.578 +/- 0.020 (14.68 +/- 0.51)	.050 (1.27)	0.010 (0.25)	N/A
0E3400K0		15A, 1/2HP, 125/250VAC	400	0.047 (1.19)	0.806 +/- 0.030 (20.47 +/- 0.76)	0.040 (1.02)	0.010 (0.25)	0.810 (20.57)
0E3450HX		15A, 1/2HP, 125/250VAC	50	0.125 (3.18)	0.600 +/- 0.045 (15.24 +/- 0.51)	0.085 (2.16)	0.030 (0.76)	1.40 (35.56)
0E3450K0		15A, 1/2HP, 125/250VAC	200	0.125 (3.18)	0.806 +/- 0.045 (20.47 +/- 1.14)	0.085 (2.16)	0.030 (0.76)	1.34 (34.04)
0E3455HX		15A, 1/2HP, 125/250VAC	22	0.300 (7.62)	0.600 +/- 0.100 (15.24 +/- 2.54)	0.187 (4.75)	0.065 (1.65)	2.757 (70.03)
0E3485HX		15A, 1/2HP, 125/250VAC	13	0.500 (12.70)	0.600 +/- 0.175 (15.24 +/- 4.45)	0.312 (7.92)	0.100 (2.54)	2.932 (74.47)

\* Measured above reference line. Refer to dimensional drawing.

\*\* Actuator tolerance +/- 0.031" (0.787).

**NOTE:** E35 and E36 available in light force only.

MINIATURE



Not recommended for new designs

Please review our D4 series

<http://www.cherrycorp.com/english/switches/miniature/d4.htm>

# E21-E36 Series

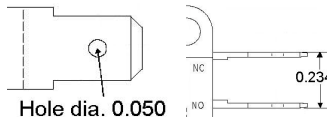
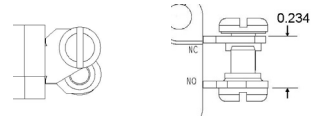
## Terminals

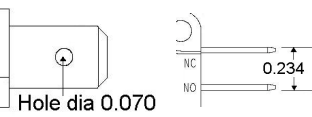
 <p>Hole dia. 0.050</p> <p>0.187 x 0.020 QC Terminals Suffix -00</p>	 <p>Screw Terminals (special order) Suffix -10</p>	 <p>Hole dia. 0.099</p> <p>Solder Terminals (special order) Suffix -20</p>	 <p>Hole dia 0.070</p> <p>0.250 x 0.032 QC Terminals Suffix -40</p>
--	---	--	--

**Note:** 0.187" Quick Connect terminals are standard i.e. part number E21-00A

To order 0.250" Quick Connect terminals 'add' the suffix to the part number, i.e. E21-40A

## Circuitry

Terminal	Standard Force			Light Force		
	SPDT	SPST NO	SPST NC	SPDT	SPST NO	SPST NC
QC 0.187"	-00A	-01A	-02A	-00AX	-01AX	-02AX
Screw	-10A	-11A	-12A	-10AX	-11AX	-12AX
Solder	-20A	-21A	-22A	-20AX	-21AX	-22AX
QC 0.250"	-40A	-41A	-42A	-40AX	-41AX	-42AX

**Note:** 1. SPDT contact arrangement is standard. In general, normally open switches may be ordered by changing the suffix number from -00 to -01 and normally closed may be ordered by changing the suffix from -00 to -02. See above for assistance.

2. E35 and E36 only available as light force with 0.250" QC terminals.

## Ordering Information

1. Select the contact rating prefix you need (E21-E36).
2. Combine the prefix with the corresponding terminal configuration. For example part number E21-00H will provide you with a gold crosspoint miniature switch with 0.187" QC terminals and a straight lever with a 0.865" actuation length
3. To order a normally open version simply 'add 1' to the suffix to obtain E21-01H and normally closed 'add 2' for part number E21-02H.
4. To order a E21-00H with .screw terminals, 'add' the new terminal code (-10) to the part number – E21-10H will be the resulting part number for a miniature switch with screw terminals and a straight lever with a 0.865" actuation length.

## Contact

Call, fax or visit our Website for more information.

**ZF Electronics Corporation**  
11200 88th Avenue  
Pleasant Prairie, WI 53158

Phone: 262.942.6500  
Web: [www.cherrycorp.com](http://www.cherrycorp.com)  
Email: [cep\\_sales@zf.com](mailto:cep_sales@zf.com)  
Fax: 262.942.6566

The manufacturer accepts no liability for errors or non-availability, and reserves the right to change specifications without prior notice.

Technical data relates to product specifications only. Features may differ from those described. Only drawings combined with product specifications shall be deemed binding.

© 2007 ZF Electronics Corporation

Last Updated: 061212

